

L05044 LED Driver 40W, 15-32 Vdc, 300-1400 mA

L1MLT140S-40E

L05045 LED Driver 40W, 15-32 Vdc, 300-1400 mA, Dimmable

L1M1MLT140S-40E

Engineered for Best Fixture Performance

Fulham LumoSeries drivers are all built on core engineering design principles for exceptional standards of performance and reliability in LED systems. Highest-grade critical components together with design features for thermal management ensure excellent reliability. Our low ripple designs create flicker-free lighting and perfectly smooth dimming. Simplicity of specification and installation is a key characteristic of all Fulham LumoSeries drivers. Hence the wide voltage and current ranges and industry leading low inrush current.



Current adjustable LED driver with low inrush current designed for the ultra-efficient operation.

Engineered for Performance

- Industry leading efficiency
- Excellent EMC behavior
- Very high power factor

Engineered for Reliability

- Low inrush current
- Thermal protection (automatic current limiter)
- Short and open circuit protection, overload and overvoltage protection

Engineered for Simplicity.

- Future-proof flexibility – industry leading voltage and current range enabling seamless support of LED generations and minimizing supply chain complexity

5 year warranty

Fulham LumoSeries takes pride in the quality of its products. We not only develop all products in house, they are also produced to ensure guaranteed reliability and performance. Fulham LumoSeries drivers come with the assurance of a 5 year warranty. After all, with typical LED lifetimes of 50,000 hours, it is critical to have a power supply with equal reliability.



Product features

- Wide output voltage range 15 - 32 Vdc
- Wide range of current settings 300 - 1400 mA
- 0-10V, 1 - 10V and potentiometer dimming (L05045 only)
- Max inrush current 1A
- Low output current ripple (<10 %) at 100 Hz
- Active output overvoltage protection
- High efficiency up to 90 % across a wide range of loads
- Power factor > 0.95
- SELV
- ENEC certified
- Engineered and Manufactured in Europe

Certificates and standards

- ENEC05, CE
- EN55015 / EN61000-3-2 / EN61347-2-13 / EN61347-1 / EN61547 / EN62384 / SELV

Classifications



Specific technical data

Type	Minimum current at minimum DIM level	Efficiency at full load	Output current	Output voltage range	Open circuit output voltage	Max. outputpower	Dimming
L05044	-	90 %	300 - 1400 mA	15 - 32 Vdc	36 Vdc	40 W @ 240 V c 32 W @ 110 Vac	No
L05045	200mA (-10% +5%)	90 %	300 - 1400 mA	15 - 32 Vdc	36 Vdc	40 W @ 240 Vac 32 W @ 110 Vac	1 - 10 V, potentiometer 100K log b (SELV)

Technical data

Rated supply voltage	220-240 Vac
Input voltage	110-240 Vac / 150-375Vdc*
Mains frequency	50/60 Hz
100 Hz ripple current at full load	< 10%
Output current tolerance	5%
Power factor at full load	> 0.95
THD	%
Nominal line current at 240 Vac	195 mA
Dimming method	Linear (L05045)
Startup time	< 1 sec
Warm up time to 95% of light output	< 2 sec
Output isolation	SELV
Surge protection (diff. / comm.)	2 kV / 6 kV
IP classification	IP 20
Circuit lifetime	50,000 hrs at Tc max.
Case dimensions	157 x 42 x 32 mm
Case material	Polyamide 6 (PA6)

* External DC fuse is required.

Dimensions

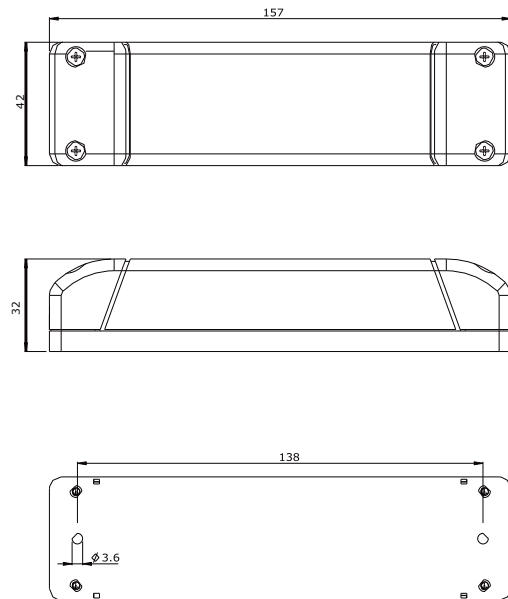

Inrush current

Mains max. peak inrush at full load	0.241A per driver on phase 60° (average starting angle)*
	0.105A per driver on phase 90° (worst case starting angle)*
	0.447A per driver on phase 60° (average starting angle)**
	1.009A per driver on phase 90° (worst case starting angle)**

** Tested at 240 Vac 1 driver connected, with TTI HA1600A analyzer.

* Tested at 240 Vac 10 drivers parallel connected, with TTI HA1600A analyzer.

Maximum number of drivers on automatic circuitbreakers

Automatic circuit breaker type	C10	C13	C16	C20	B10	B13	B16	B20
L05044 / L05045	44	57	70	88	44	57	70	88

Thermal specifications

Ambient temperature range (Ta)	-25 to 60°C*
Maximum case temperature (Tc)	< 80°C
Storage temperature range	-20 to 60°C

* When mounted on a heat conductive surface of at least 100x100x2 mm,
Otherwise Ta max = 40°C

Over temperature protection

The LED drive is protected against thermal overload. If the temperature limit is exceeded, the output current is reduced.

Ambient temperature and cooling

The rated ambient temperature is defined for a driver mounted on a thermally conductive surface of 200cm² per driver. When the driver is not cooled, thermal protection might trigger at a lower temperature and the output power will be reduced. When not mounted on a thermally conductive surface it is recommended to limit the maximum ambient temperature at 40°C. Always check if the surface is sufficient enough before installing the driver.

LED load

Fulham LumoSeries LED drivers are designed to drive passive LEDs, -COB's and -LED assemblies
Proper function is not guaranteed when (LED)loads with active components are used.

Short-circuit protection

In case of a short circuit the LED driver switches to protection mode. After the removal of the short-circuit the LED driver will recover automatically.

No-load operation

In no-load operation the output voltage will not exceed the specified open circuit output voltage.

Thermal overload protection

When the maximum output power is exceeded, the LED driver reduces the output current. After elimination of the overload the normal operation is restored automatically.

Dimming

The L05045 can be dimmed using a potentiometer (100K log advised) or with a 1-10V dimmer / system.

Only dimmers with a minimum of class II protection may be used.

The driver cannot be switched off by the dimmer.

The minimum dim level is 200mA (-10% + 5%)

Wiring diagram

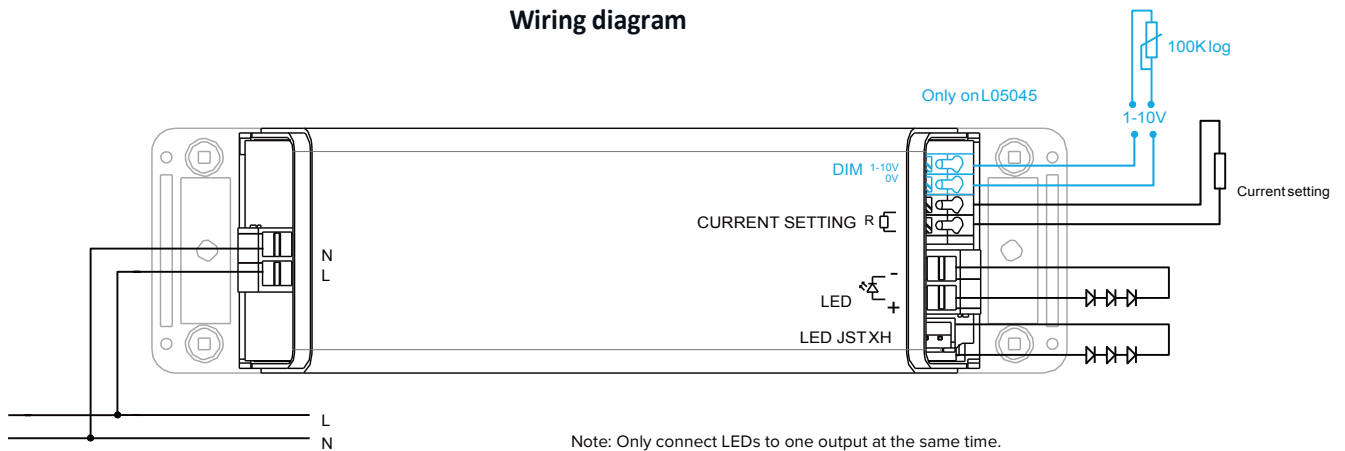

Wiring of device

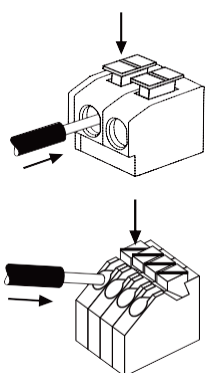

Solid

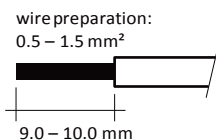

Stranded

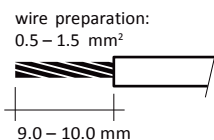

wire preparation: 0.2 – 1.5 mm²

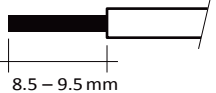

wire preparation: 0.2 – 1.5 mm²

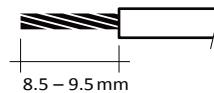

Output current resistor setting

Resistance (Ω)	Output current (mA)
∞ (no resistor)	1400 (+2% / -5%)
68K	1200 (+2% / -5%)
22K	1000 (+2% / -5%)
5K6	700 (+2% / -5%)
2K2	500 - 550
390	350 - 400
0Ω (short)	300 - 365

Ordering data

Part	Part number	Alternate part number	EAN code	Packaging carton	Multibox carton	Weight per piece
L05044 40W, 300-1400 mA	L05044	L1MLT140S-40E	8718801703373	50 pieces	150 pieces	175 g
L05045 40W, 300-1400 mA, Dimmable	L05045	L1M1MLT140S-40E	8718801703403	50 pieces	150 pieces	175 g

Berenkoog 56
NL-1822 BZ Alkmaar
The Netherlands

www.Fulham.com

© 2018, Fulham Company All rights reserved. Designs and specifications may change without prior notice. Fulham products are not designed, intended, or authorized for any application in which the failure of the product could cause personal injury.

Formerly Lumotech.

Datasheet L05044 / L05045